

# 5/79 S BATTUTE PER PORTE E PORTONCINI

SET OF TOOLS FOR MULTIPROFILE DOORS

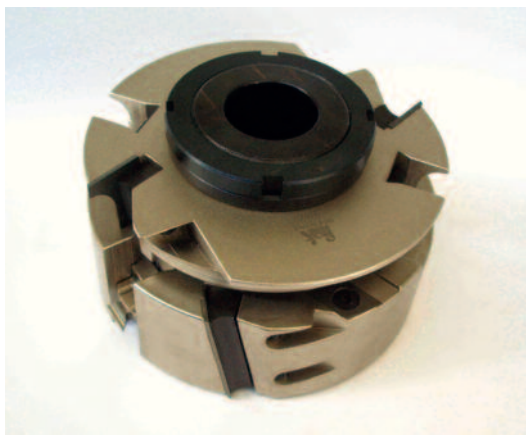

GRUPPO DI FRESE CON COLTELLINI IN HW PROFILATI CON BATTUTA 11,15,18 mm PER SQUADRATURA DI PORTE

SET OF TOOLS WITH PROFILED HW KNIVES TO SQUARE DOORS WITH 11,15,18 mm RABBET

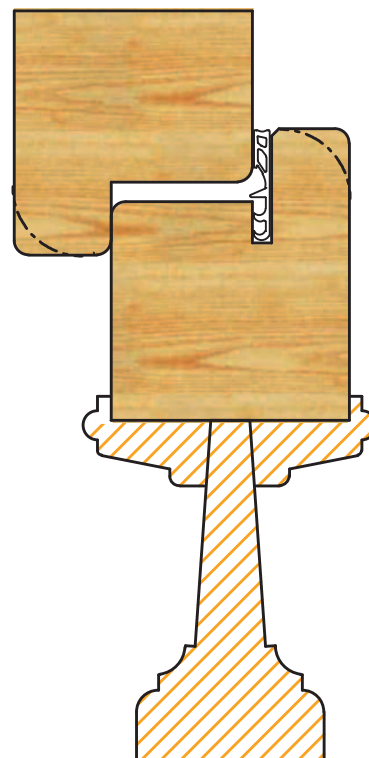

5/79 S

**MAN MEC**

Codice nr. HW	FRESA CUTTER	D. mm.	B mm.	d. mm.	Z+V+R
------------------	-----------------	-----------	----------	-----------	-------

1	125 min	25	60	2	2 2
2	147	50	60	2	2 2 2

5/79S-11 BATTUTA 11mm GRUPPO-SET OF TOOLS-1+2

1	125 min	25	60	2	2 2
2	155	50	60	2	2 2 2

5/79S-15 BATTUTA 15mm GRUPPO-SET OF TOOLS-1+2

1	125 min	25	60	2	2 2
2	161	50	60	2	2 2 2

5/79S-18 BATTUTA 18mm GRUPPO-SET OF TOOLS-1+2

FORI MOZZO-BORES SLEEVE-mm 30-35-40-50

NELL'ORDINE INDICARE IL TIPO DI PROFILO  
SPECIFY THE REQUESTED PROFILE

Ricambi/Spare parts

Codice nr. Dimensioni

000/0180	14x14x2	
000/0180P	28x16x2	
000/0G4D	4 mm	
000/194	45°	
000/195	R3	
000/018	M5x8	
000/039A	T25	

79P.... =====> 25x25x2====>COLTELLI PROFILATI/PROFILED KNIVES =====>

000/186	50x12x1.5	
139/23	CN23 mm	
000/166	C46 mm	
000/008	M8x15	
000/026	M5	
000/031	2.5 mm	
000/032	4 mm	
000/044	0.8 mm	
000/214A		

CALIBRO/GAUGE

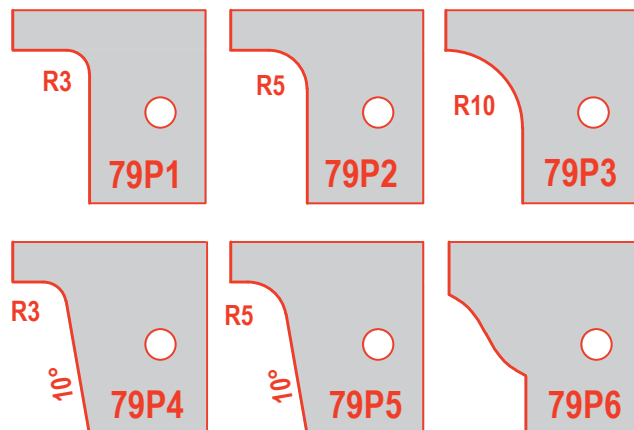
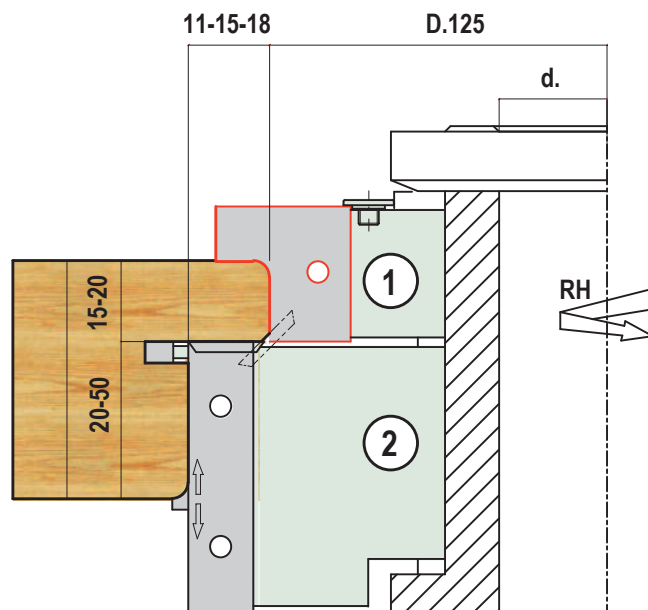

# PORTE

**TELAIO CLASSICO**  
5/67 5/76 5/79 5/79D  
BATTUTE 11mm 15mm  
GIUNZIONI ANGOLARI 5/57 5/68

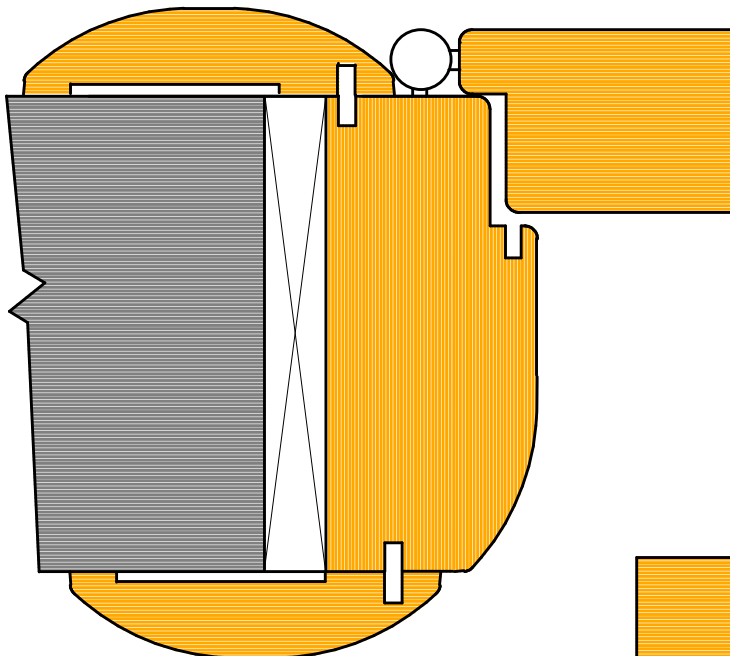
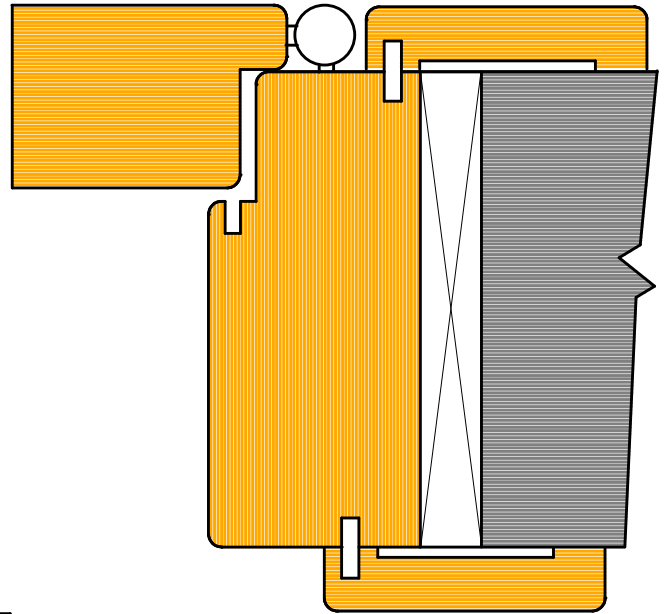

**TELAIO TUTTO TONDO**  
5/67 5/67S 5/76 5/79 5/79D  
GIUNZIONI ANGOLARI 5/57 5/68

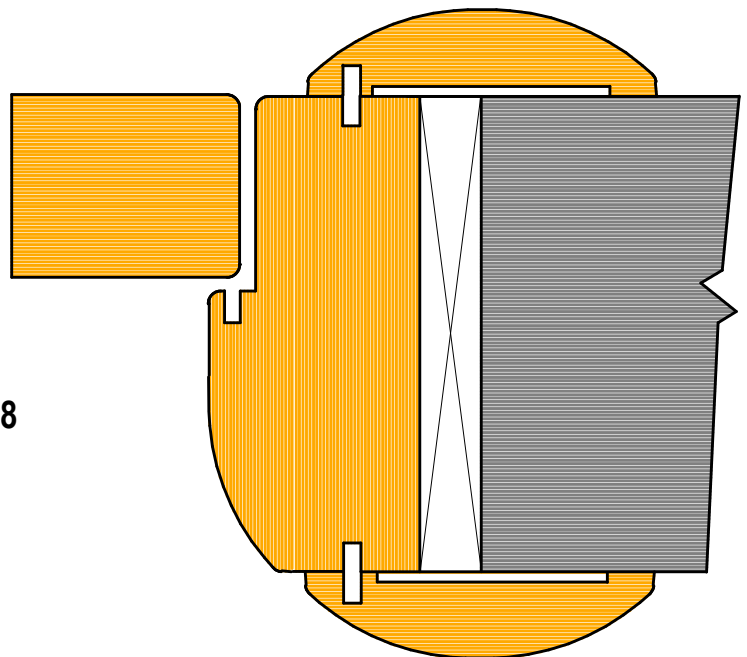

# PORTE

