

5/137L 5P137L GRUPPI PER PORTONCINI

MAN

MEC

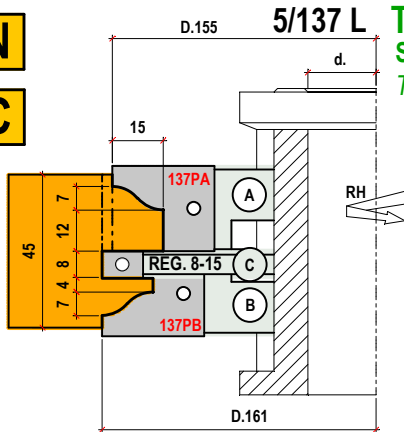

5/137 L TENONE SEMPLICE
SPESSORE 45-54 mm
THICKNESS 45-54 mm

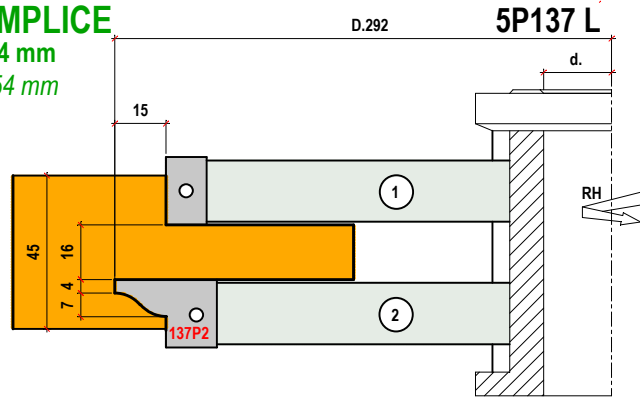

5P137 L

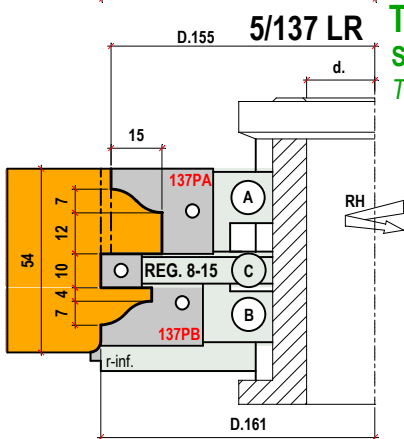

5/137 LR TENONE SEMPLICE CON RAGGI
SPESSORE 54-59 mm
THICKNESS 54-59mm

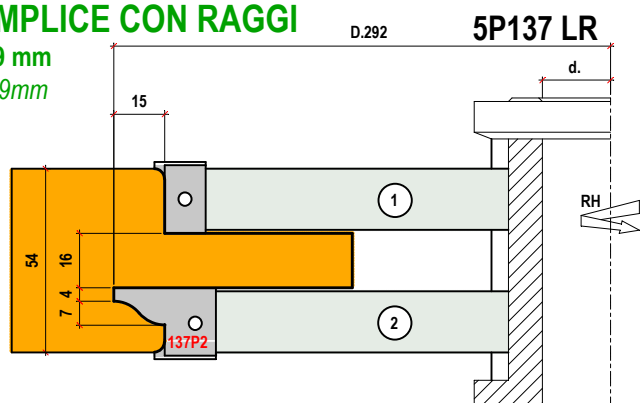

5P137 LR

GRUPPI PER PORTE PER VETRO O PANNELLO AD INFILARE.
SET FOR DOORS WITH SINGLE INSERTED GLASS OR WOOD PANEL.

RECUPERO LISTELLO

PROFILI Z=2 TENONI Z=4
PROFILES Z=2 TENONS Z=4

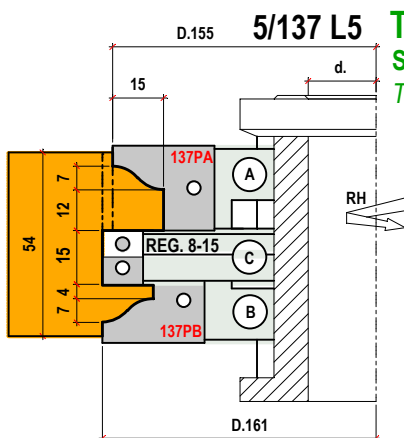
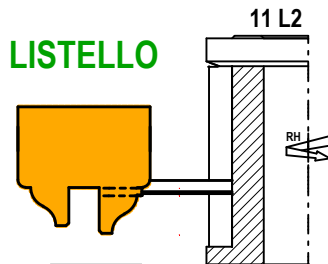

5/137 L5 TENONE DOPPIO
SPESSORE 54-56 mm
THICKNESS 54-56 mm

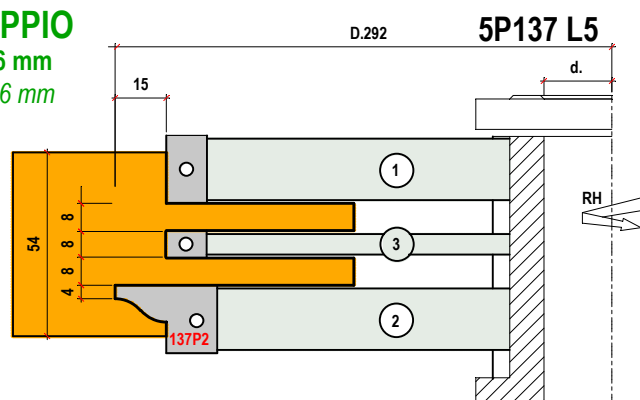

5P137 L5

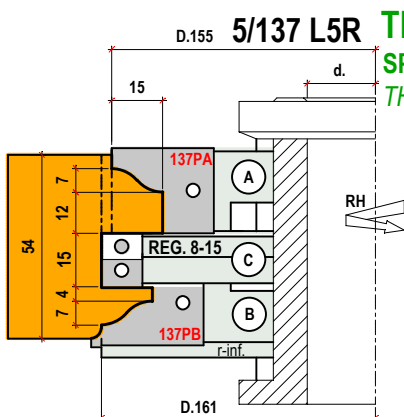

5/137 L5R TENONE DOPPIO CON RAGGI
SPESSORE 54-59 mm
THICKNESS 54-59 mm

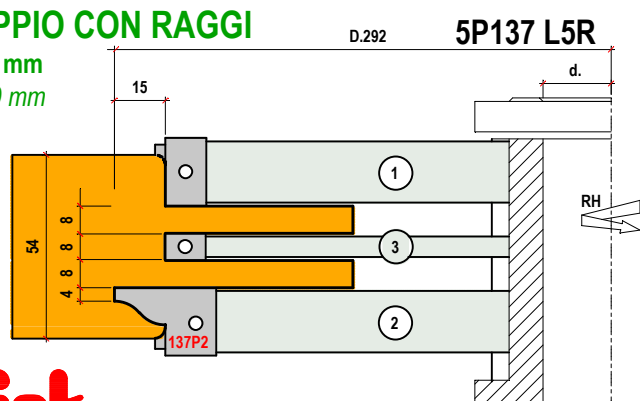

5P137 L5R

5/137 PROFILI E RICAMBI

PROFILI INTERCAMBIABILI PER GRUPPI 5/137 DAL 2011

SPESSORI DA 40 A 59 mm SECONDO LE VERSIONI.

PROFILES INTERCHANGEABLE ON SET 5/137 FROM YEAR 2011

THICKNESS FROM 40 TO 59 mm ACCORDING THE VERSION TYPE.

SCALA 1:1

FULL SIZE SCALE

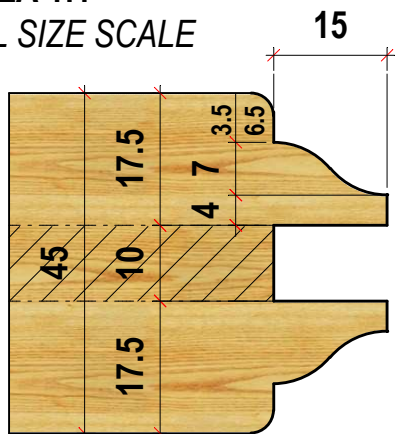

SAGOMA

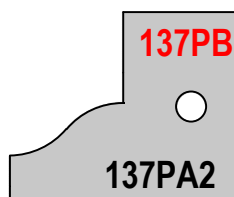
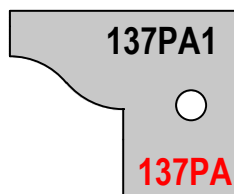

TENONE

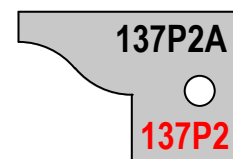
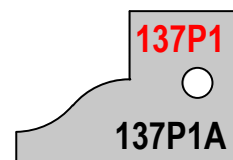

CODICI IN COLORE ROSSO VALGONO PER UTENSILI VENDUTI FINO AL 31-12-2010
CODICI IN COLORE NERO VALGONO PER UTENSILI VENDUTI A PARTIRE DAL 2011

