

FRESE PER ELETTROFRESATRICI PORTATILI

ROUTER BITS FOR ELECTRIC ROUTERS

353

Codice HW	D. mm.	L2. mm.	S x A mm.	Z
353 H 03	3	8	6-8x25	2+1
353 H 04	4	10	6-8x25	2+1
353 H 05	5	15	6-8x25	2+1
353 H 06	6	18	6-8x25	2+1

353 H 08	8	20	6-8x25	2+1
353 H 08A	8	30	6-8x25	2+1
353 H 09	9	20	6-8x25	2+1
353 H 10	10	20	6-8x25	2+1
353 H 10A	10	30	6-8x25	2+1
353 H 11	11	20	6-8x25	2+1
353 H 12	12	20	6-8x25	2+1
353 H 12A	12	30	6-8x25	2+1
353 H 13	13	20	6-8x25	2+1
353 H 14	14	20	6-8x25	2+1
353 H 15	15	20	6-8x25	2+1
353 H 16	16	20	6-8x25	2+1
353 H 18	18	20	6-8x25	2+1
353 H 20	20	20	6-8x25	2+1
353 H 22	22	20	6-8x25	2+1
353 H 24	24	20	6-8x25	2+1
353 H 25	25	20	6-8x25	2+1

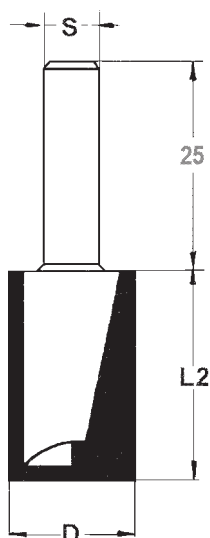

D.3-4-5-6 mm. HW integrale - D.3-4-5-6 mm.Solid carbide

GAMBO 6/8 mm. - SHANK 6-8 mm.

356

Codice HW	D. mm.	L2. mm.	S x A mm.	Z
356 H 09	9,5	13	6-8x25	2
356 H 13	13	15	6-8x25	2
356 H 19	19	15	6-8x25	2

GAMBO 6/8 mm. - SHANK 6-8 mm.

Ricambi - spare parts

Viti - Screws

V3C - M3x10 svasato

V3D - M3x10

Cuscinetti - Ball-bearing:

BB09 - per art. 356H09 - 9,52x3,96x3,17

BB13 - per art. 356H13 - 13x4x5

BB19 - per art. 356H19 - 19x6x6

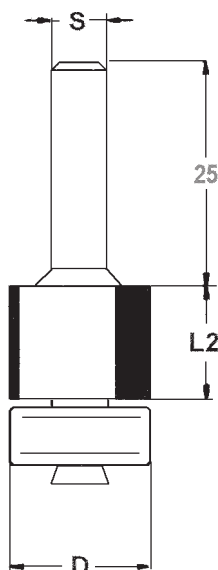

FRESE PER ELETTROFRESATRICI PORTATILI

ROUTER BITS FOR ELECTRIC ROUTERS

357

Codice HW	D. mm	L2. mm	S x A mm	Z
357 H 6	6	18	6x25	2
357 H 8	8	18	8x25	2

GAMBO 6-8 mm. - SHANK 6-8 mm.

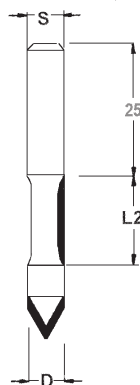

359

Codice HW	D. mm	L2. mm	Angolo (°)	S x A mm	Z
359 H 11	11	18	5°	6-8x25	2

GAMBO 6-8 mm. - SHANK 6-8 mm.

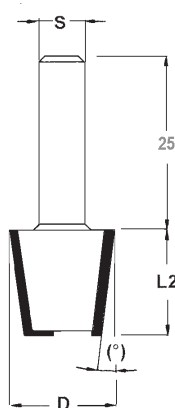

360

Codice HW	D. mm	L2. mm	Angolo (°)	S x A mm	Z
360 H 08	8	12	10°	6-8x25	2
360 H 11	11	14	10°	6-8x25	2
360 H 14	14	18	10°	6-8x25	2

GAMBO 6-8 mm. - SHANK 6-8 mm.

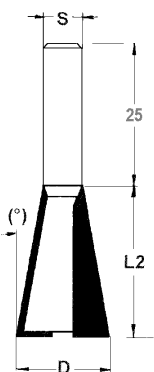

361

Codice HW	D. mm	L2. mm	Angolo (°)	S x A mm	Z
361H	15	15	22°	6-8x25	1

GAMBO 6-8 mm. - SHANK 6-8 mm.



FRESE PER ELETTROFRESATRICI PORTATILI

ROUTER BITS FOR ELECTRIC ROUTERS

362

Codice HW	D. mm	L2. mm	Angolo (°)	S x A mm.	Z
362 H	19	18	45°	6-8x25	2

GAMBO 6-8 mm. - SHANK 6-8 mm.

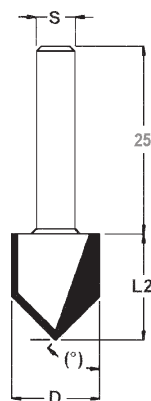

363

Codice HW	D. mm	L2. mm	Angolo (°)	S x A mm.	Z
363 H 10	24	14	10°	6-8x25	2
363 H 15	24	14	15°	6-8x25	2
363 H 30	24	12	30°	6-8x25	2
363 H 45	24	9	45°	6-8x25	2

GAMBO 6-8 mm. - SHANK 6-8 mm.

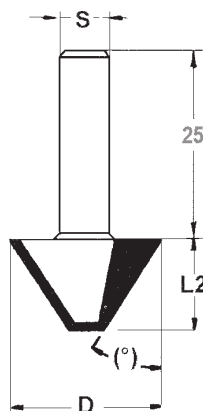

365

Codice HW	D. mm	L2. mm	Angolo (°)	S x A mm.	Z
365 H 19	19	13	15°	6-8x25	2
365 H 22	22	12	25°	6-8x25	2
365 H 32	32	11	45°	6-8x25	2

GAMBO 6-8 mm. - SHANK 6-8 mm.

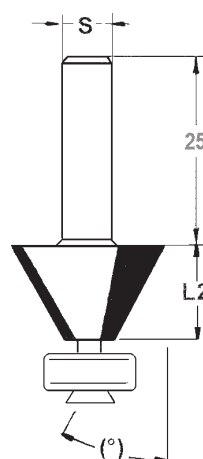

Ricambi - spare parts

Cuscinetto - Ball-bearing:

BB13 - 13x4x5

Viti - Screws

V4D - M3x10 tipo D

FRESE PER ELETTROFRESATRICI PORTATILI

ROUTER BITS FOR ELECTRIC ROUTERS

366

Codice HW	D. mm	L2. mm	Angolo (°)	S x A mm.	Z
366 H 22	12	12	22°	6-8x25	2
366 H 30	12	12	30°	6-8x25	2
366 H 45	12	12	45°	6-8x25	2

GAMBO 6-8 mm. - SHANK 6-8 mm.

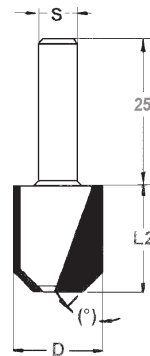

367

Codice HW	D. mm	L2. mm	Angolo (°)	S x A mm.	Z
367 H	19-26	15	0-45°	6-8x25	2

GAMBO 6-8 mm. - SHANK 6-8 mm.

Ricambi - spare parts

Cuscinetto - Ball-bearing:

BB19 - 19x6x6

Viti - Screws -

V4C - M3x10 tipo C svasata

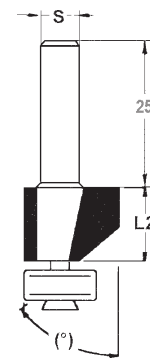

368

Codice HW	D. mm	L2. mm	Angolo (°)	S x A mm.	Z
368 H	28	15	45°	6-8x25	2

GAMBO 6-8 mm. - SHANK 6-8 mm.

Ricambi - spare parts

Cuscinetto - Ball-bearing:

BB16 - 16x5x5

Viti - Screws -

V4C - M4x12 tipo C svasata

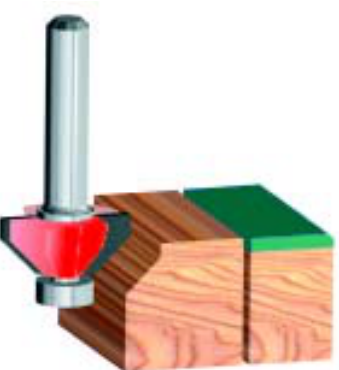
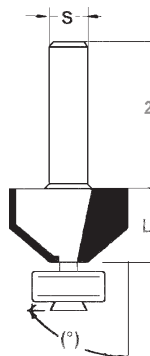

FRESE PER ELETTROFRESATRICI PORTATILI

ROUTER BITS FOR ELECTRIC ROUTERS

369

Codice HW	R mm.	D. mm.	L2. mm	S x A mm	Z
369 H 06	3	6	12	6-8x25	2
369 H 08	4	8	14	6-8x25	2
369 H 10	5	10	15	6-8x25	2
369 H 12	6	12	16	6-8x25	2
369 H 14	7	14	16	6-8x25	2
369 H 16	8	16	16	6-8x25	2
369 H 20	10	20	20	6-8x25	2

GAMBO 6-8 mm. - SHANK 6-8 mm.

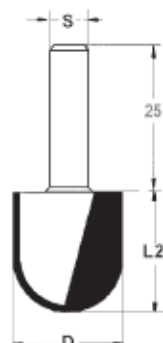

371

Codice HW	R mm.	D. mm.	L2. mm	S x A mm.	Z
371 H 21	4	21	18	6-8x25	2
371 H 23	5	23	18	6-8x25	2
371 H 25	6	25	18	6-8x25	2
371 H 29	8	29	18	6-8x25	2
371 H 33	10	33	18	6-8x25	2

GAMBO 6-8 mm. - SHANK 6-8 mm.

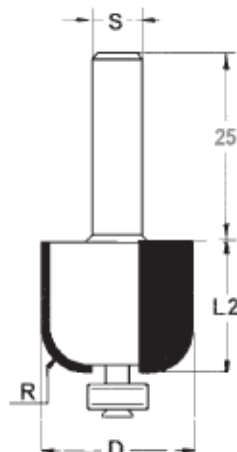

Ricambi - spare parts

Cuscinetto - Ball-bearing:

BB13 - 13x4x5

Viti - Screws -

V4D - M3x10

372

Codice HW	R mm.	D. mm.	L2. mm.	SxA mm.	Z
372 H 03	3	19	12	6-8x25	2
372 H 04	4	22	16	6-8x25	2
372 H 05	5	25	19	6-8x25	2
372 H 06	6	28	22	6-8x25	2
372 H 08	8	31	25	6-8x25	2
372 H 10	10	35	30	6-8x25	2

GAMBO 6-8 mm. - SHANK 6-8 mm.



FRESE PER ELETTROFRESATRICI PORTATILI

ROUTER BITS FOR ELECTRIC ROUTERS - GAMBO 6-8 mm. - SHANK 6-8 mm.

373

Codice HW	R mm.	D. mm.	L2. mm.	SxA mm.	Z
373 H 03	3	12	7	6-8x25	2
373 H 04	4	14	9	6-8x25	2
373 H 05	5	16	11	6-8x25	2
373 H 06	6	18	13	6-8x25	2
373 H 08	8	22	15	6-8x25	2
373 H 10	10	26	17	6-8x25	2

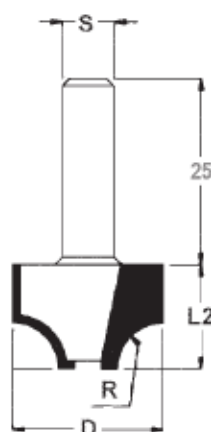

374

Codice HW	R mm.	D. mm.	L2. mm.	SxA mm.	Z
374 H 03	3	19	8	6-8x25	2
374 H 04	4	22	10	6-8x25	2
374 H 05	5	24	12	6-8x25	2
374 H 06	6	26	13	6-8x25	2
374 H 08	8	30	15	6-8x25	2
374 H 10	10	34	17	6-8x25	2
374 H 12	12	38	19	6-8x25	2

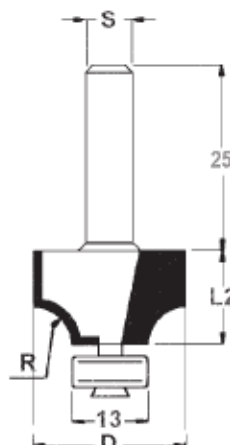

Ricambi - spare parts

Cuscinetto - Ball-bearing:

BB13 - 13x4x5

Viti - Screws -

V4D - M3x10

375

Codice HW	R mm.	D. mm.	L2. mm.	SxA mm.	Z
375 H 03	3	19	8	6-8x25	2
375 H 04	4	22	10	6-8x25	2
375 H 05	5	24	12	6-8x25	2
375 H 06	6	26	13	6-8x25	2
375 H 08	8	30	15	6-8x25	2
375 H 10	10	34	17	6-8x25	2
375 H 12	12	38	19	6-8x25	2



Ricambi - spare parts

Cuscinetto - Ball-bearing:

BB10 - 10x4x5

Viti - Screws -

V4D - M3x10

FRESE PER ELETTROFRESATRICI PORTATILI

ROUTER BITS FOR ELECTRIC ROUTERS - GAMBO 6-8 mm. - SHANK 6-8 mm.

378

Codice HW	R mm	D. mm	L2. mm	S x A mm	Z
378 H 4	4-4	29	13	6-8x25	2
378 H 6.3	6.3-6.3	38	18	6-8x25	2

Ricambi - spare parts

Cuscinetto - Ball-bearing:

BB10 - 10x4x4

Viti - Screws - V4D - M3x10

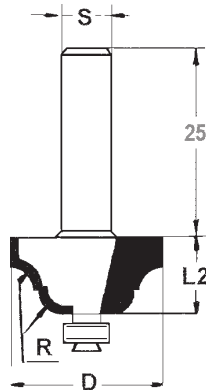

379

Codice HW	R mm	D. mm	L2. mm	S x A mm	Z
379 H 4	4-4	25.5	12	6-8x25	2
379 H 4.8	4.8-4.8	28.5	14.5	6-8x25	2
379 H 6.4	6.4-6.4	35	17.5	6-8x25	2

Ricambi - spare parts

Cuscinetto - Ball-bearing:

BB10 - 10x4x4

Viti - Screws - V4D - M3x10

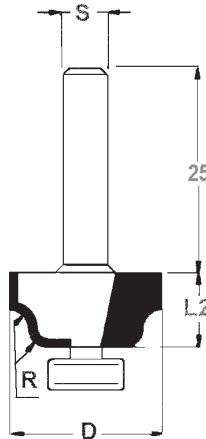

380 - 381

Codice HW	D. mm.	H. mm.	Z
380 H 1.5	40	1.5	2
380 H 1.8	40	1.8	2
380 H 2	40	2	2
380 H 2.2	40	2.2	2
380 H 2.5	40	2.5	2
380 H 2.8	40	2.8	2
380 H 3	40	3	2
380 H 3.2	40	3.2	2
380 H 3.5	40	3.5	2
380 H 4	40	4	2
380 H 5	40	5	2
380 H 6	40	6	2

381 albero - arbor S=6-8 mm.

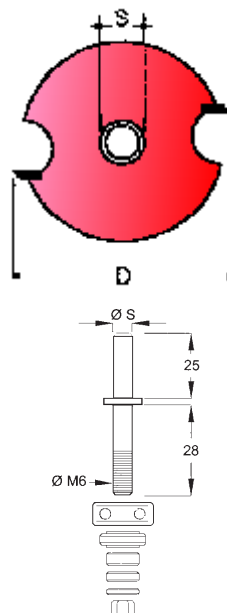

FRESE PER ELETTROFRESATRICI PORTATILI

F ROUTER BITS FOR ELECTRIC ROUTERS

382

Codice HW	R mm	D. mm	L2. mm	S x A mm	Z
-----------	------	-------	--------	----------	---

382 H 10 25 12 6-8x25 2

GAMBO 6-8 mm. - SHANK 6-8 mm.

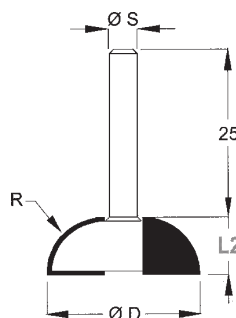

383

Codice HW	R mm	D. mm	L2. mm	S x A mm	Z
-----------	------	-------	--------	----------	---

383 H 8-4 44 25 6-8x25 2

GAMBO 6-8 mm. - SHANK 6-8 mm.

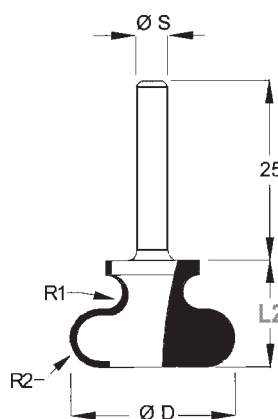

384

Codice HW	R mm	D. mm	L2. mm	S x A mm	Z
-----------	------	-------	--------	----------	---

384 H 25 41 14 6-8x25 2

GAMBO 6-8 mm. - SHANK 6-8 mm.

Ricambi - spare parts

Cuscinetto - Ball-bearing:

BB10 - 10x4x4

Viti - Screws -

V4D - M3x10

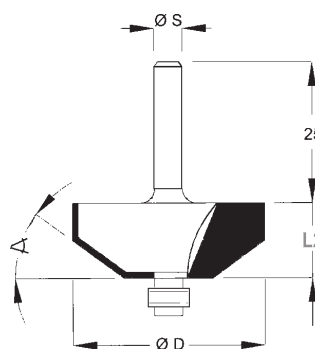

FRESE PER ELETTROFRESATRICI PORTATILI

ROUTER BITS FOR ELECTRIC ROUTERS - GAMBO 6/8 mm. - SHANK 6/8 mm.

385

Codice HW	R mm	D. mm	L2. mm	S x A mm	Z
385 H 4	4	29	13	6-8x25	2
385 H 6	6	37	18	6-8x25	2

Ricambi - spare parts

Cuscinetti - Ball-bearing:

BB13 - 13x4x5

Viti - Screws - V4D - M3x10 tipo D

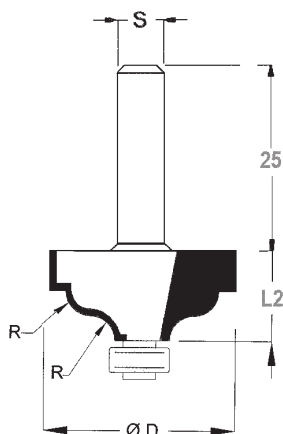

386

Codice HW	R mm	D. mm	L2. mm	S x A mm	Z
386 H 4	4	29	13	6-8x25	2
386 H 6	6	37	16	6-8x25	2

Ricambi - spare parts

Cuscinetto - Ball-bearing:

BB13 - 13x4x5

Viti - Screws -

V4D - M3x10 tipo D

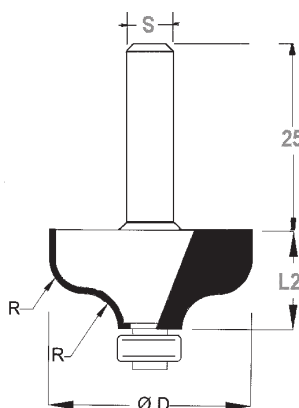

387

Codice HW	R mm	D. mm	L2. mm	S x A mm	Z
387 H 4	4	29	15	6-8x25	2
387 H 6	6	37	18	6-8x25	2

Ricambi- spare parts

Cuscinetti - Ball-bearing:

BB13 - 13x4x5

Viti - Screws -

V4D - M3x10 tipo D

